

D k6	L	dk	S
5,0	17	3,1	0,20
6,0	13	3,1	0,20
8,0	20	4,6	0,25
10,0	20	4,6	0,25
12,0	25	6,4	0,50
16,0	33	8,4	0,60
20,0	33	11,0	0,60

Material / material:  
1.4112 stainless steel  
gehärtet / hardened:  
54 ± 2 HRC  
Feder rostfreier  
Federstahl

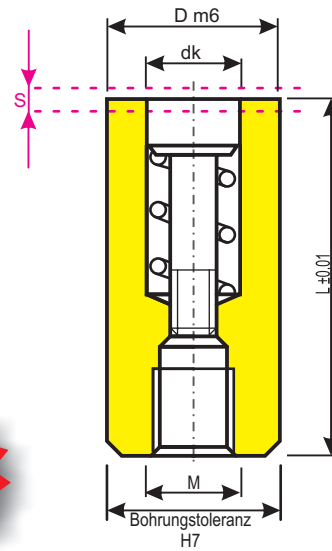

**Der Klassiker!**

**Komplett**  
(complete)

**Hülse**  
(outer insert)

**Stellschraube**  
(inner insert)

12 Monate,  
Zeiger  
mit Jahreszahl  
month/year



- LD - MY5/ \_ S
- LD - MY6/ \_ S
- LD - MY8/ \_ S
- LD - MY10/ \_ S
- LD - MY12/ \_ S
- LD - MY16/ \_ S
- LD - MY20/ \_ S



- LD - M5
- LD - M6
- LD - M8
- LD - M10
- LD - M12
- LD - M16
- LD - M20



- LD S 5/ \_
- LD S 6/ \_
- LD S 8/ \_
- LD S 10/ \_
- LD S 12/ \_
- LD S 16/ \_
- LD S 20/ \_

12 Monate,  
Zeiger  
ohne Jahreszahl  
month

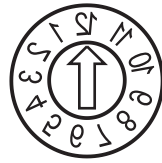

- LD - M5S
- LD - M6S
- LD - M8S
- LD - M10S
- LD - M12S
- LD - M16S
- LD - M20S

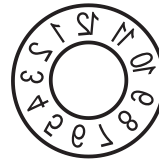

- LD - M5
- LD - M6
- LD - M8
- LD - M10
- LD - M12
- LD - M16
- LD - M20



- LD S 5
- LD S 6
- LD S 8
- LD S 10
- LD S 12
- LD S 16
- LD S 20

Dieses Jahr und  
6 folgende  
year

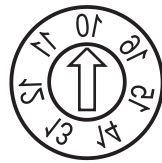

- LD - Y5S
- LD - Y6S
- LD - Y8S
- LD - Y10S
- LD - Y12S
- LD - Y16S
- LD - Y20S

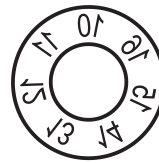

- LD - Y5
- LD - Y6
- LD - Y8
- LD - Y10
- LD - Y12
- LD - Y16
- LD - Y20



- LD S 5
- LD S 6
- LD S 8
- LD S 10
- LD S 12
- LD S 16
- LD S 20

31 Monatstage  
days

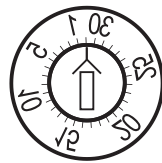

- LD - D5E
- LD - D6E
- LD - D8E
- LD - D10E
- LD - D12E
- LD - D16E
- LD - D20E

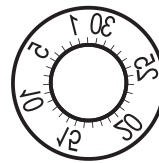

- LD - D5
- LD - D6
- LD - D8
- LD - D10
- LD - D12
- LD - D16
- LD - D20



- LD E 5
- LD E 6
- LD E 8
- LD E 10
- LD E 12
- LD E 16
- LD E 20

Woche,  
Zeiger mit  
Jahreszahl  
weeks with year



- LD - WY5/ \_ S
- LD - WY6/ \_ S
- LD - WY8/ \_ S
- LD - WY10/ \_ S
- LD - WY12/ \_ S
- LD - WY16/ \_ S
- LD - WY20/ \_ S

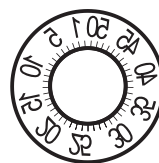

- LD - W5
- LD - W6
- LD - W8
- LD - W10
- LD - W12
- LD - W16
- LD - W20



- LD E 5/ \_
- LD E 6/ \_
- LD E 8/ \_
- LD E 10/ \_
- LD E 12/ \_
- LD E 16/ \_
- LD E 20/ \_

# LD

## Komplett (complete)

## Hülse (outer insert)

## Stellschraube (inner insert)

Woche  
ohne Jahreszahl  
weeks

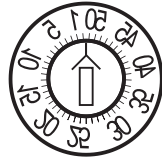

LD - W 6 E  
LD - W 8 E  
LD - W 10 E  
LD - W 12 E  
LD - W 16 E  
LD - W 20 E

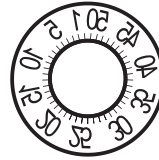

LD - W 6  
LD - W 8  
LD - W 10  
LD - W 12  
LD - W 16  
LD - W 20



LD - E 6  
LD - E 8  
LD - E 10  
LD - E 12  
LD - E 16  
LD - E 20

Schicht  
shift

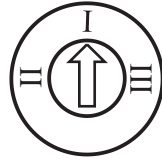

LD - I-III 5 S  
LD - I-III 6 S  
LD - I-III 8 S  
LD - I-III 10 S  
LD - I-III 12 S  
LD - I-III 16 S  
LD - I-III 20 S

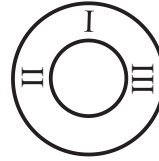

LD - I-III 5  
LD - I-III 6  
LD - I-III 8  
LD - I-III 10  
LD - I-III 12  
LD - I-III 16  
LD - I-III 20



LD - S 5  
LD - S 6  
LD - S 8  
LD - S 10  
LD - S 12  
LD - S 16  
LD - S 20

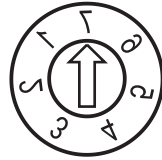

LD - 7D 5 S  
LD - 7D 5 S  
LD - 7D 5 S  
LD - 7D 5 S  
LD - 7D 5 S  
LD - 7D 5 S

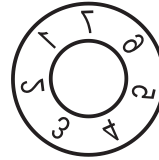

LD - 7D 5  
LD - 7D 5  
LD - 7D 5  
LD - 7D 5  
LD - 7D 5  
LD - 7D 5



LD - S 5  
LD - S 6  
LD - S 8  
LD - S 10  
LD - S 12  
LD - S 16  
LD - S 20

## Kombinationen

Tage  
(kann durch Pos. 4  
ersetzt werden)  
days  
replacement  
through pos. 4)

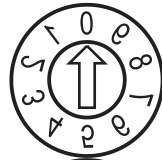

KLD - 030 5 S  
KLD - 030 6 S  
KLD - 030 8 S  
KLD - 030 10 S  
KLD - 030 12 S  
KLD - 030 16 S  
KLD - 030 20 S

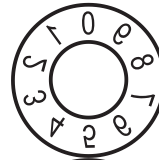

LD - 0-9 5  
LD - 30 5  
LD - 0-9 6  
LD - 30 6  
LD - 0-9 8  
LD - 30 8  
LD - 0-9 10  
LD - 30 10  
LD - 0-9 12  
LD - 30 12  
LD - 0-9 16  
LD - 30 16  
LD - 0-9 20  
LD - 30 20



LD - S 5  
LD - S 5  
LD - S 6  
LD - S 6  
LD - S 8  
LD - S 8  
LD - S 10  
LD - S 10  
LD - S 12  
LD - S 12  
LD - S 16  
LD - S 16  
LD - S 20  
LD - S 20

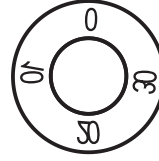
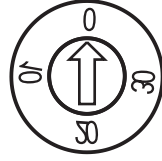

Wochen  
(kann durch Pos. 5  
ersetzt werden)  
weeks  
replacement  
through pos. 5)

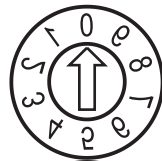

KLD - 050 5 S  
KLD - 050 6 S  
KLD - 050 8 S  
KLD - 050 10 S  
KLD - 050 12 S  
KLD - 050 16 S  
KLS D - 050 20 S

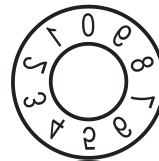

LD - 0-9 5  
LD - 50 5  
LD - 0-9 6  
LD - 50 6  
LD - 0-9 8  
LD - 50 8  
LD - 0-9 10  
LD - 50 10  
LD - 0-9 12  
LD - 50 12  
LD - 0-9 16  
LD - 50 16  
LD - 0-9 20  
LD - 50 20



LD - S 5  
LD - S 5  
LD - S 6  
LD - S 6  
LD - S 8  
LD - S 8  
LD - S 10  
LD - S 10  
LD - S 12  
LD - S 12  
LD - S 16  
LD - S 16  
LD - S 20  
LD - S 20

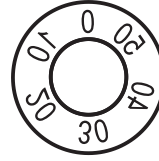
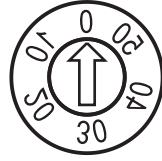

Wochen im Jahr  
(kann durch Pos. 6  
ersetzt werden)  
weeks / year  
replacement  
through pos. 6)

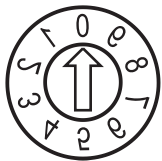

KLD - 050 5/\_ S  
KLD - 050 6/\_ S  
KLD - 050 8/\_ S  
KLD - 050 10/\_ S  
KLD - 050 12/\_ S  
KLD - 050 16/\_ S  
KLD - 050 20/\_ S

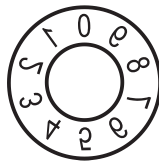

LD - 0-9 5  
LD - 50 5  
LD - 0-9 6  
LD - 50 6  
LD - 0-9 8  
LD - 50 8  
LD - 0-9 10  
LD - 50 10  
LD - 0-9 12  
LD - 50 12  
LD - 0-9 16  
LD - 50 16  
LD - 0-9 20  
LD - 50 20



LD - S 5  
LD - S 5/\_  
LD - S 6  
LD - S 6/\_  
LD - S 8  
LD - S 8/\_  
LD - S 10  
LD - S 10/\_  
LD - S 12  
LD - S 12/\_  
LD - S 16  
LD - S 16/\_  
LD - S 20  
LD - S 20/\_

